



DATA SHEET

CTV 210-R

Air velocity and temperature transmitter



Airflow function



Two 4-wire analogue output 0-5/10 V or 0/4-20 mA



2 relay outputs



ABS V0 IP65 housing, with or without display

Features

- Configurable ranges from 0 to 30 m/s with hot wire probe
- Configurable range from 0 to 50 °C in temperature
- Power supply 24 Vdc/Vac or 100-240 Vac
- Trend indicator
- "1/4 turn" system mounting with wall-mount plate

Part number

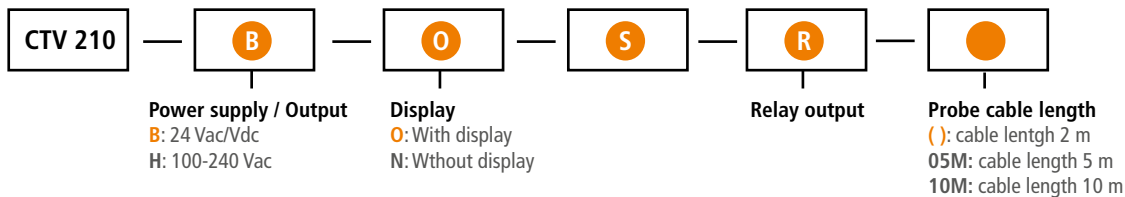

Example: CTV210 – BOS – R



Air velocity and temperature transmitter, power supply 24 Vac/Vdc, with display and relay outputs, probe cable length of 2 m.

Technical specifications

Parameter	Accuracy*	Measuring range	Unit	Response time	Resolution
Pt100 Temperature	±0.3% of reading ±0.25 °C	From 0 to +50 °C	°C, °F	T ₉₀ = 0.9 second for V _{air} = 1 m/s	0.1 °C, 0.1 °F
Air velocity	From 0 to 3 m/s: ±3% of reading ±0.03 m/s From 3 to 30 m/s: ±3% of reading ±0.1 m/s	From 0 to 30 m/s	m/s, fpm, km/h	T ₆₃ = 1.6 s	From 0 to 3 m/s: 0.01 m/s From 3 to 30 m/s: 0.1 m/s

*All the accuracies indicated in this technical datasheet were stated in laboratory conditions, and can be guaranteed for measurements carried out in the same conditions, or carried out with calibration compensation.

General features

Power supply	24 Vac / Vdc $\pm 10\%$ 100-240 Vac, 50-60 Hz Warning: risk of electric shock 
Output	2 x 4-20 mA or 2 x 0-20 mA or 2 x 0-5 V or 2 x 0-10 V (4 wires) Common mode voltage <30 Vac Maximum load: 500 Ohms (0/4-20 mA) Minimum load: 1 K Ohms (0-5/10 V)
Relay outputs	2 changeover relays 3 A / 230 V NO : 5A / NC: 3A / 240 Vac
Galvanic isolation	Inputs and outputs (models 100-240 Vac) Device fully protected by DOUBLE ISOLATION or REINFORCED ISOLATION  Outputs (models 24 Vac/Vdc)
Consumption	CTV210-B: 6 VA CTV210-H: 8 VA
Electrical connection	Screw terminal block for cable 2.5 mm ² Carried out according to the code of good practice
PC communication	USB-Mini Din cable
Environment	Air and neutral gases
Type of fluid	Temperature: air and neutral gases Air velocity: clean air
Conditions of use (°C/%RH/m)	From -10 to +50 °C. In non-condensing condition. From 0 to 2000 m.
Storage temperature	From -10 to +70 °C
Security	Protection class II; Pollution degree 2; Overvoltage category 2 (OVCI)
European directives	2014/30/EU EMC; 2014/35/EU Low Voltage; 2011/65/EU RoHS II; 2012/19/EU WEEE

Functions

Class 210 transmitters have two analogue outputs which correspond to the two parameters displayed. It is possible to activate one or two outputs and for each output, to select between air velocity, temperature and air flow.

Functions / Features	Measuring ranges	Units and resolutions
Airflow	From 0 to 99 999 dam ³ /h (according to air velocity and duct dimension)	1 m ³ /h – 0.1 m ³ /s – 1 dam ³ /h 0.1 l/s – 1 cfm

Technical features of the hot wire probe

Material	Stainless steel 316 L
Dimensions	Ø 8 mm, length 300 mm
Operating temperature	From 0 to +50 °C
Cable	PVC Ø 4.8 mm, length 2 m

Features of the housing

Material	ABS V0 as per UL94
Protection	IP65
Display	75 x 40 mm, LCD 20 digits 2 lines. Height of digits: Values: 10 mm; Units: 5 mm
Cable gland	For cables Ø 8 mm maximum
Weight	340 g

Dimensions

All dimensions are in millimeters.

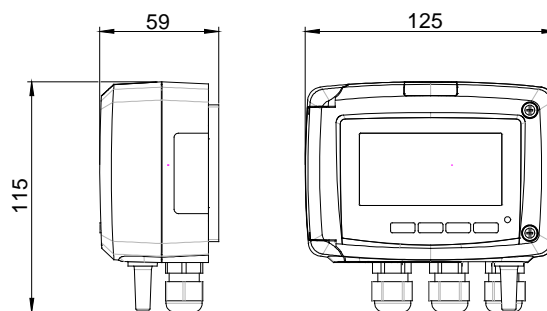

Connections

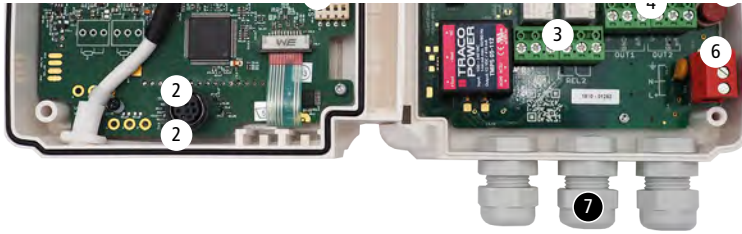

1. DIP switch (d)
2. LCC-S software connection
3. Relays
4. Analogue outputs (a)
5. F3.20* fuse
6. Power supply terminal block (c)
7. Cable glands

Power supply type (b) specified on the label on the side of the transmitter

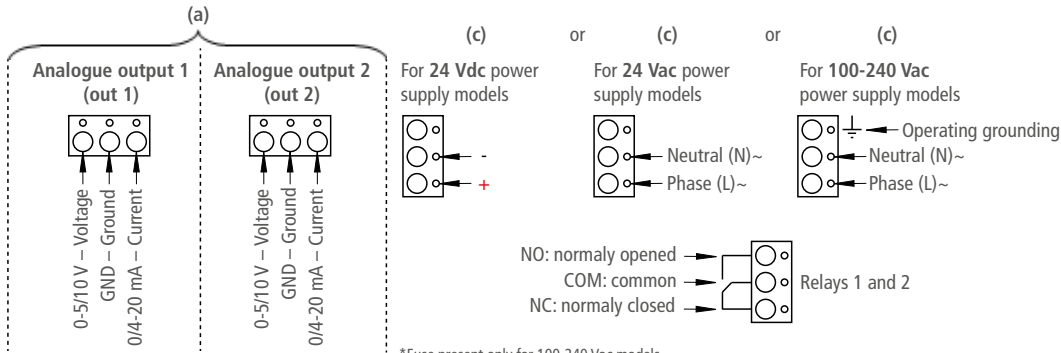
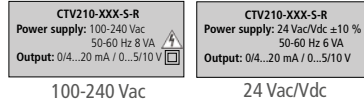

*Fuse present only for 100-240 Vac models.

Every fuse replacement must be performed with a power off device using a TR5 630 mA 250 V fuse.



Electrical connections as per NFC15-100 standard



This connection must be made by a formed and qualified technician. To make the connection, the transmitter must not be energized. Before making the connection, you must first check the power supply indicated on the transmitter board (see (b) on "Connections" part). The presence of a switch and a circuit breaker upstream the device is compulsory.

- For transmitters with 24 Vdc power supply:

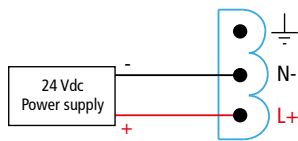

- For transmitters with 24 Vac power supply:

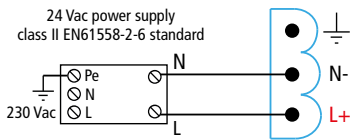

or

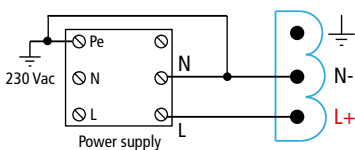

- For transmitters with 100-240 Vac power supply:

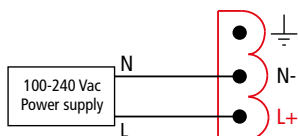

The selection of the output signal in voltage (0-10 V or 0-5 V) or in current (4-20 mA or 0-20 mA) is made via the DIP switch (d) of the electronic board of the transmitter: put the on-of switches as shown in the table below:

Configurations	4-20 mA	0-10 V	0-5 V	0-20 mA
Combinations				

- Connection of the output in current 4-20 mA:

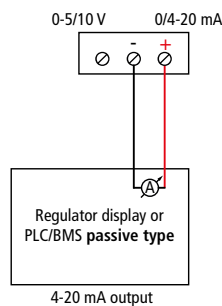

- Connection of output in voltage 0-10 V:

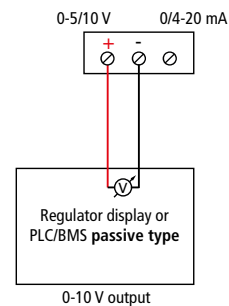

On 100-240 Vac models, if a fuse protection is used for the power line, it is imperative to use delayed-action fuses in order to absorb the surge of current when first turned on the transmitter.

Configuration of the transmitters

It is possible on the class 210 to configure all the parameters of the transmitter: units, measuring ranges, outputs, channels, calculation functions, etc, via different methods:

- **Via keypad for models with display:** a code-locking system allows to secure the installation (See class 210 transmitters user manual).
- **Via software (optional) on all models.** Simple user-friendly configuration. See LCC-S user manual.

Configurable analogue output:

It is possible to configure your own intermediary ranges (minimum range: from 0 to 1 m/s).

Configure the range according to your needs: outputs are automatically adjusted to the new measuring range

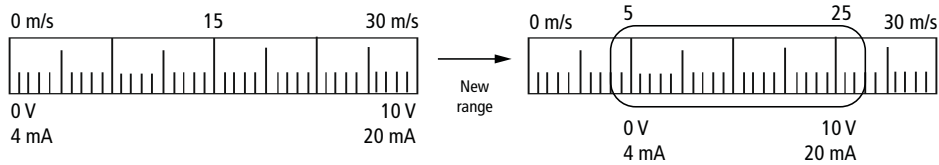

Mounting

To mount the transmitter, mount the ABS plate on the wall (drilling: Ø 6 mm, screws and pins are supplied).

Insert the transmitter on the fixing plate (see A on the drawing beside). Rotate the housing in clockwise direction until you hear a “click” which confirms that the transmitter is correctly installed.

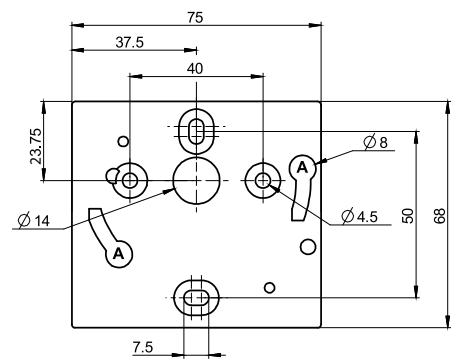

All dimensions are in millimeters.

Maintenance

Please avoid any aggressive solvent. Please protect the transmitter and its probes from any cleaning product containing formalin, that may be used for cleaning rooms or ducts.

Calibration

Outputs diagnostic: with this function, you can check with a multimeter (or on a regulator / display, or a PLC / BMS) if the transmitter outputs work properly. The transmitter generates a voltage of 0 V, 5 V and 10 V or a current of 4 mA, 12 mA and 20 mA.

Certificate: class 210 transmitters are supplied with adjusting certificates. Calibration certificates are available as option.

Precautions for use

Please always use the device in accordance with its intended use and within parameters described in the technical features in order not to compromise the protection ensured by the device.

Options and accessories

Name	Reference
Configuration software with USB cable	LCC-S
Calibration certificate	-
Sliding fittings	-
Mounting brackets	-
Clean spray for hotwire probe	-



Only the accessories supplied with the device must be used.